

謎の円盤

アダムスキー型 UFO

ペーパークラフト

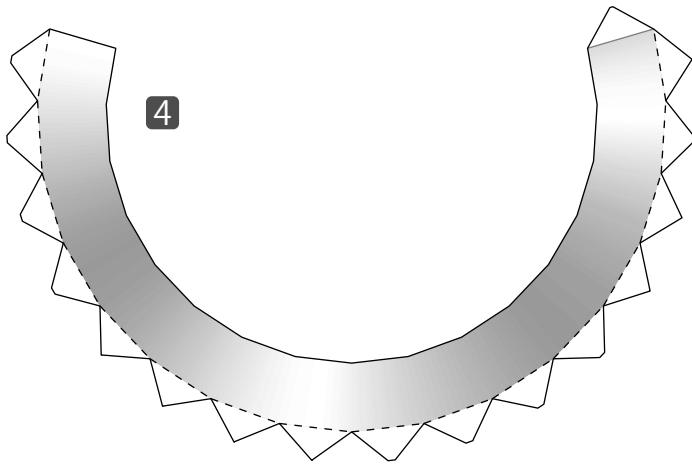
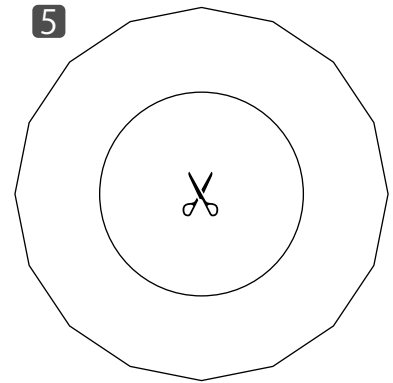
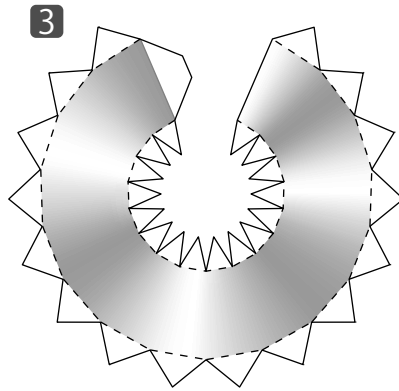
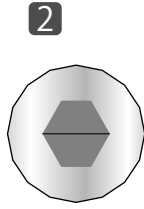
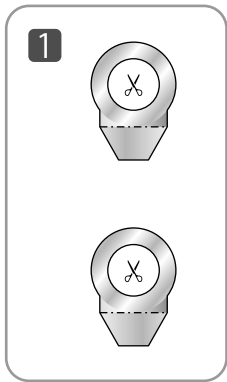

展開図内の指示について

- 山折り線
- - - - - 谷折り線
- ✂ 切り抜き

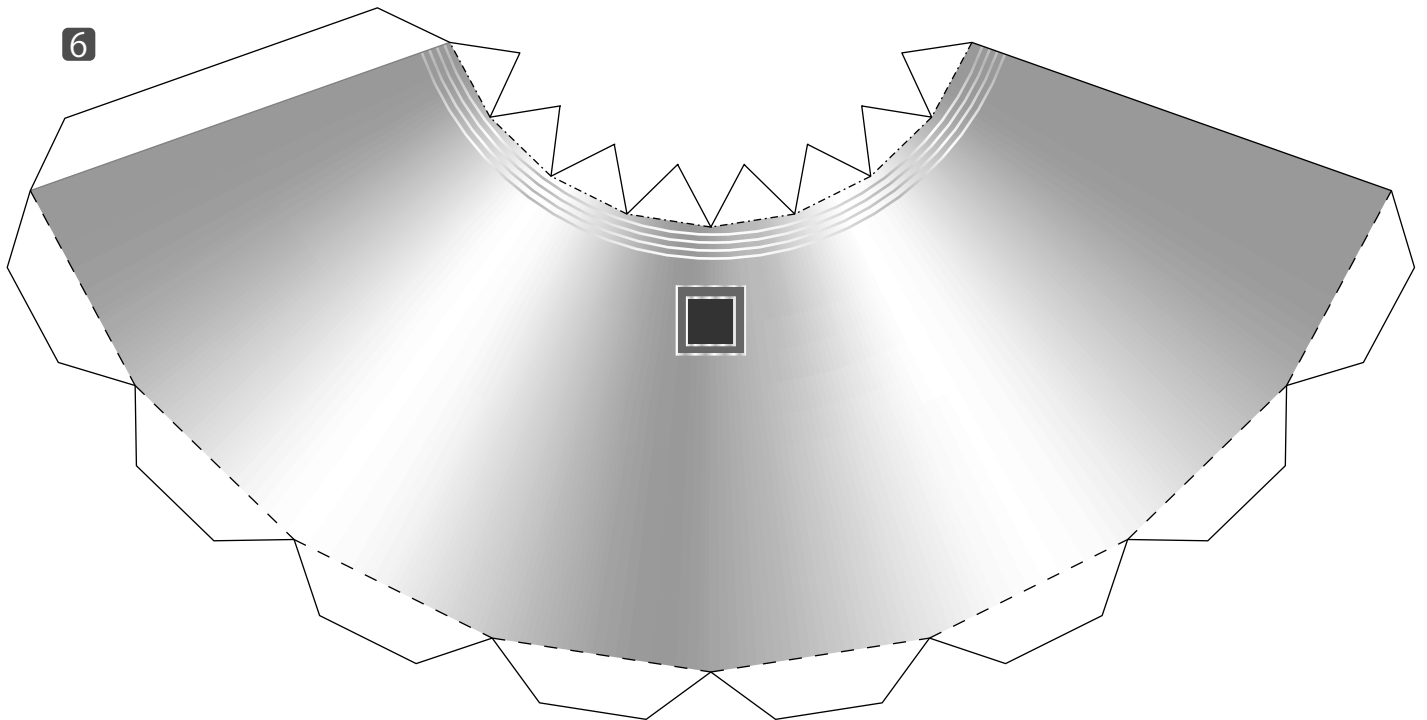

7

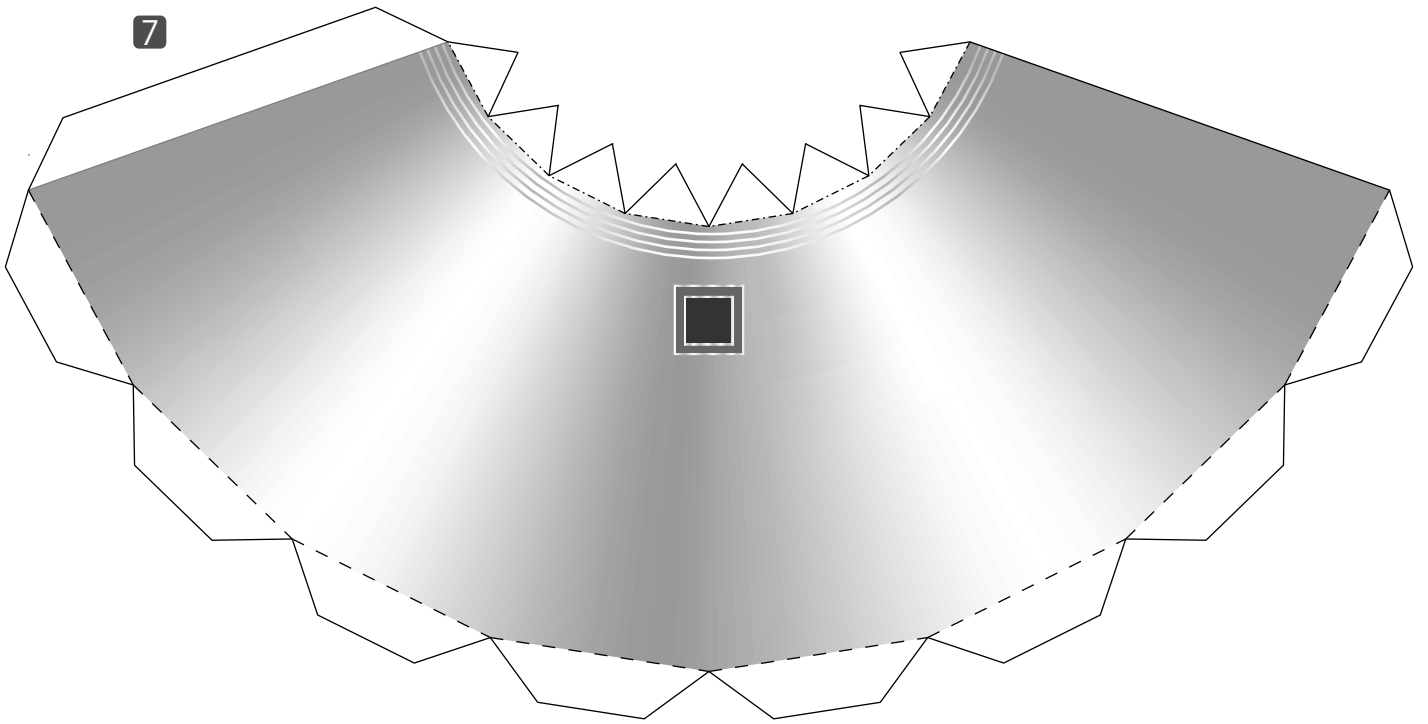

8

